

8MP LightHunter Deep Learning Dome Network Camera

IPC328SS-DF28(40)K-IO



Key Features



Optics

- 1/2.8", Powered by lighthunter
- Smart IR, up to 40m (131 ft) IR distance
- Up to 120 dB Optical WDR (Wide Dynamic Range)

Smart

- Smart intrusion prevention, support false alarm filtering, include Cross Line, Intrusion, Enter Area, Leave Area detection
- People Counting, support people flow counting and crowd density monitoring, suitable for different statistical scenarios

Compression

- Ultra 265, H.265, H.264, MJPEG
- Triple streams
- 3840*2160@20fps in the main stream
- ROI (Region of Interest)

Network

- ONVIF Conformance

Structure

- DC12V or PoE power supply
- Wide voltage range of $\pm 25\%$ in DC
- Micro SD, up to 256 GB
- Alarm 1 in and 1 out, Audio 1 in and 1 out
- IP67 ingress protection
- IK10 vandal resistant

Specifications

	IPC328SS-DF28K-I0	IPC328SS-DF40K-I0			
Camera					
Sensor	1/2.8", 8.0 megapixel, progressive scan, CMOS				
Lens	2.8mm@F1.6	4.0mm@F1.6			
Iris	Fixed				
DORI Distance	Lens (mm)	Detect (m)	Observe (m)	Recognize (m)	Identify (m)
	2.8	86.9(285.1ft)	34.8(114.0ft)	17.4(57.0ft)	8.7(28.5ft)
	4.0	124.1(407.3ft)	49.7(162.9ft)	24.8(81.5ft)	12.4(40.7ft)
Field of View (H)	96.6°		86.5°		
Field of View (V)	50.8°		48.2°		
Field of View (D)	125.6°		106.4°		
Shutter	Auto/Manual, 1 ~ 1/100000s				
Adjustment angle	Pan: 0°~355°		Tilt: 0°~80°	Rotate: 0°~355°	
Min. Illumination	Colour:0.0025lux (F1.6, AGC ON) 0 lux with IR				
WDR	120dB				
Day/Night	IR-cut filter with auto switch (ICR)				
S/N	>56dB				
IR Range	Up to 40m (131 ft) IR range				
Wavelength	850nm				
IR On/Off Control	Auto/Manual				
Defog	Digital Defog				
Video					
Video Compression	Ultra 265, H.265, H.264, MJPEG				
Frame Rate	Main Stream: 8MP(3840*2160),Max 20fps; Sub Stream: 2MP (1920*1080), Max 30fps; Third Stream: D1 (720*576), Max 30fps				
Video Bit Rate	128 Kbps~16 Mbps				
ROI	Supported				
Video stream	Triple streams				
OSD	Up to 8 OSDs				
Privacy Mask	Up to 8 areas(8 blacks/8 mosaics)				

Image	
White Balance	Auto/Outdoor/Fine Tune/Sodium Lamp/Locked/Auto2
Digital noise reduction	2D/3D DNR
Smart IR	Support
Flip	Normal/Flip Vertical/Flip Horizontal/180°/90°Clockwise/90°Anti-clockwise
HLC	Support
BLC	Support
Intelligent	
Smart intrusion prevention	Support false alarm filtering: Cross Line detection, Intrusion detection, Enter Area detection, Leave Area detection
Statistical Analysis	People counting, support people flow counting and crowd density monitoring
Events	
Basic Detection	Motion detection, Audio detection, Tampering alarm
General Function	Watermark, IP Address Filtering, Alarm input, Alarm output, Access Policy, ARP Protection, RTSP Authentication, User Authentication
Exception Detection And Statistics	Object Removed, Object Left Behind
Audio	
Audio Compression	G.711U,G.711A
Two-way Audio	Supported
Suppression	Supported
Sampling Rate	8KHZ
Storage	
Edge Storage	Micro SD, up to 256 GB
Network Storage	ANR,NAS(NFS)
Network	
Protocols	IPv4, IGMP, ICMP, ARP, TCP, UDP, DHCP, PPPoE, RTP, RTSP, RTCP, DNS, DDNS, NTP, FTP, UPnP, HTTP, HTTPS, SMTP, 802.1x, SNMP, QoS, RTMP
Compatible Integration	ONVIF (Profile S, Profile G, Profile T), API
Client	EZStation EZLive Ezview
Web Browser	Plug-in required live view: IE 10 and above, Chrome 45 and above, Firefox 52 and above, Edge 79 and above
Interface	
Audio I/O	Audio cable
	1 Input: impedance 35kΩ; amplitude 2V [p-p]
	1 output: impedance 600Ω; amplitude 2V [p-p]
Alarm I/O	1/1
Network	1 * RJ45 10M/100M Base-TX Ethernet
Certification	
EMC	CE-EMC (EN 55032: 2015+A1:2020,EN 61000-3-3: 2013+A1: 2019,EN IEC 61000-3-2: 2019+A1: 2021,EN 55035: 2017+A11:2020) FCC (FCC CFR 47 part15 B, ANSI C63.4-2014)
Safety	CE LVD (EN 62368-1:2014+A11:2017) CB (IEC 62368-1:2014) UL (UL 62368-1, 2nd Ed., Issue Date: 2014-12-01)
Environment	CE-RoHS (2011/65/EU;(EU)2015/863); WEEE (2012/19/EU); Reach (Regulation (EC) No 1907/2006)
Protection	IP67 (IEC 60529:1989+AMD1:1999+AMD2:2013) IK10 (IEC 62262:2002)

General	
Power	DC12V(±25%), PoE(IEEE 802.3af)
	Power consumption: Max 5W
Dimensions (∅ x H)	∅109 x 81mm(∅4.3" x 3.2")
Weight	0.43kg(0.95lb)
Working Environment	-40°C ~ 60°C (-40°F ~ 140°F), Humidity: ≤95% RH (non-condensing)
Storage Environment	-40°C ~ 70°C (-40°F ~ 158°F), Humidity: ≤95% RH (non-condensing)
surge protection	2KV

Dimensions

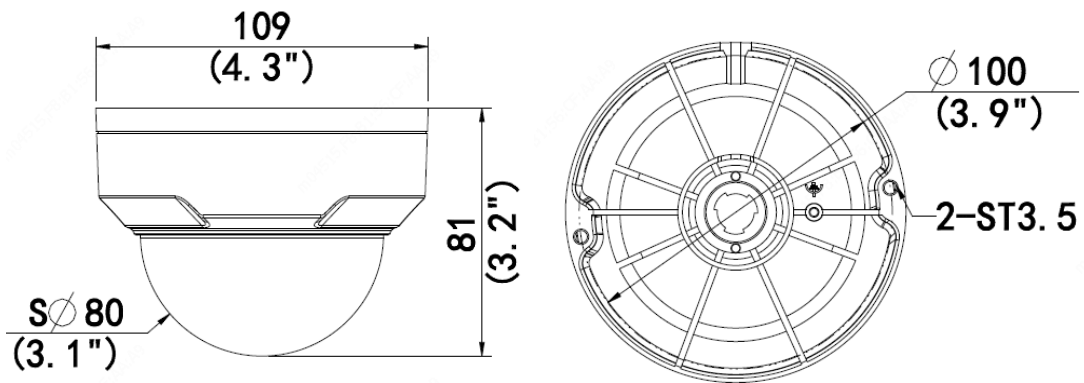

Accessories

TR-JB03-G-IN
Junction Box



TR-JB07/WM03-G-IN
Wall Mount



TR-WM03-D-IN
Wall Mount



TR-UM06-E-IN
Incline Ceiling Mount



TR-A01-IN
Waterproof Joint



TR-UP06-IN
Pole Mount

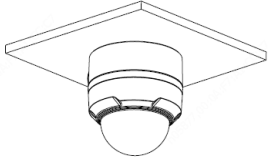
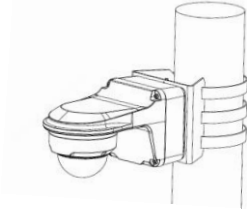
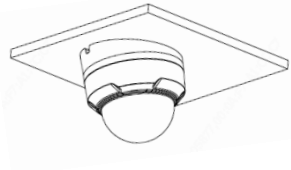
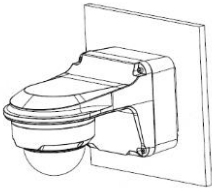

Junction Mount	Pole Mount
TR-JB03-G-IN+ TR-A01-IN	TR-JB07/WM03-G-IN,TR-WM03-D-IN+TR-UP06-IN
	
Tilted Mount	Wall Mount
TR-UM06-E-IN	TR-JB07/WM03-G-IN,TR-WM03-D-IN
	

Zhejiang Uniview Technologies Co., Ltd.

Building No.10, Wanlun Science Park, Jiangling Road 88, Binjiang District, Hangzhou, Zhejiang, China (310051)

 Email: overseasbusiness@uniview.com; globalsupport@uniview.com
<http://www.uniview.com>

©2020-2022 Zhejiang Uniview Technologies Co., Ltd. All rights reserved.

*Product specifications and availability are subject to change without notice